

CreatBot 3D Printer

User manual

English V7.3

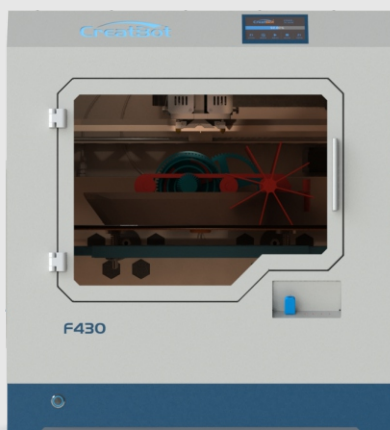

CONTENTS

Notice	3	Mouse Operation	22
Machine Diagram		Model Rotate/Scale	22
Front	4	Model Mirror	23
Printer Head	5	View Mode	24
Hardware Installation		Right Click on Model	25
Unpacking	6	Toolpath Structure	25
Printer Operation		Basic Setting	26
Leveling Platform	7	Advanced Setting	27
Paving Crepe Paper	7	Expert Setting	28
Load Filament	8	Skirt/Brim/Raft	29
Unload Filament	9	Plugins	29
Main menu	10	Start/End Gcode	30
Status page	11	Dual Head Printing	30
Detail page	12	Align Dual Head Horizontal ..	31
Printing page	13	Add Multi Type Printer	32
Axis operation	14	Print Different Filament	32
Filament menu	15	Using skills	
SD Card/U-disk	16	Change Fuse	33
Setting menu	17	Routine Maintenance.....	33
Info. menu	18	Installation section	34
Software Operation		Software	35
CreatWare Setup	19	Remove prints	35
Quick Print UI	20	Hardware Troubleshoot	36
Print Your First Model	20	Printing Troubleshoot	37
Full Setting UI	21	Specifications	38

Icon conventions



Tip icon to remind users to have a good method or technique.



Note icon, to remind the user must be given adequate attention.



Prohibition icons, prevents users from unauthorized operation.

Notice

Read First

Thank you for choosing CreatBot 3D printer!

This manual contains important information about the installation, use, maintenance and common problems of CreatBot 3D printer. Please read this manual carefully before using 3D printer. All losses caused by the breach of the notes and the operation process of the operation process will be borne by the user. Please use the filament provided by CreatBot, or high quality filament by third manufacturers. Due to the use of third party inferior material caused by the failure of the printer, the loss will be borne by the user.

Software running environment, 2G or above processors, at least 1G memory, compatible with Windows, MAC, or Linux, please use memory as much as possible.

I wish you have fun with CreatBot 3D printer!

Danger Warning



The nozzle's temperature will reach 300 degrees, don't touch.



The platform's temperature will reach 120 degrees, don't touch.



Please make sure that the printer connected to the ground.



Do not attempt to open the case, be careful of electric shock.

Working Environment



The 3D printer can work in the indoor environment of 5 °C to 30 °C.



Long-term not use of the printer, be sure to dust, moisture.



Long-term not use of the filament, please be sealed to prevent deterioration.

Machine Diagram

Front and Back

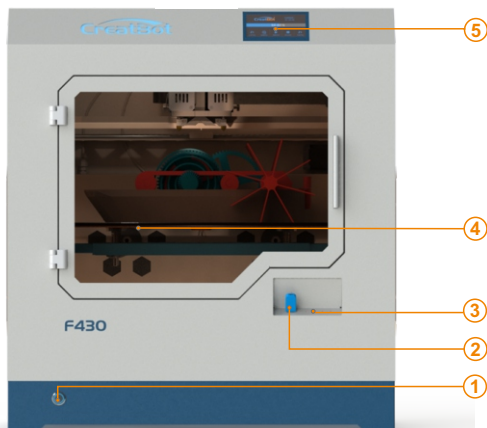

- 1. Power switch
- 2. Usb input
- 3. Indicator light
- 4. Hot bed
- 5. Touch screen

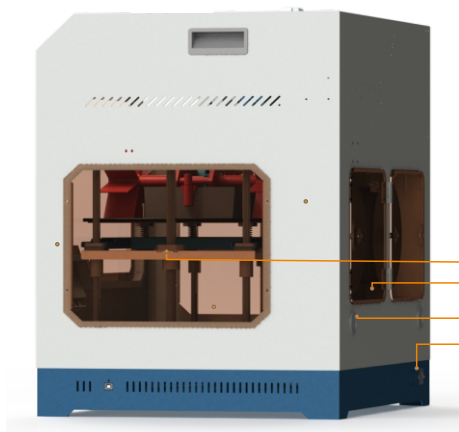

- 1. Power input
- 2. Air filter
- 3. Filament space
- 4. Z ball screw

Machine Diagram

Indicator light

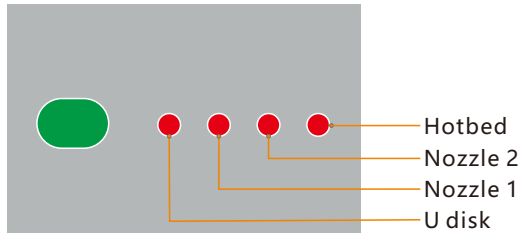

Printer Head

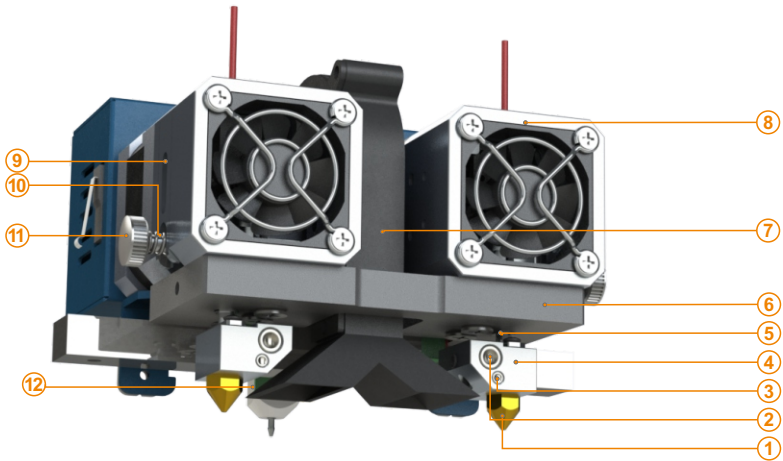

- | | | |
|-------------------|------------------|--------------------|
| 1.Nozzle | 5.Heatbreak | 9.Pressure arm |
| 2.Heating tube | 6.Extruder block | 10.Pressure spring |
| 3.Thermostat tube | 7.Cooling fan | 11.Pressure nut |
| 4.Heating block | 8.Extruder box | 12.steering engine |

Hardware Installation

Unpacking



Turn on printer

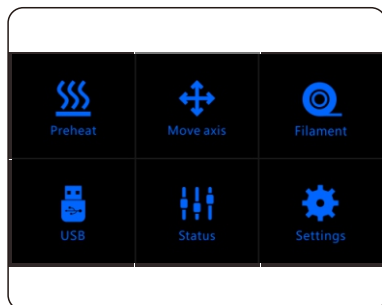

Up platform

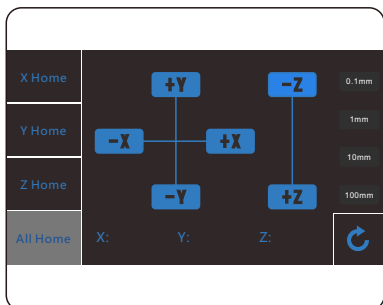

Up platform



Take out filament

1. Ensure the packing is not broken.
2. Need two people at the same time.
3. Lift it out by grasping the frame, not the belt or rails.
4. Turn on the printer, enter "Move axis" menu, select "All home", the bracket will rise, now you can takeout filament.

Printer Operation

Leveling Platform

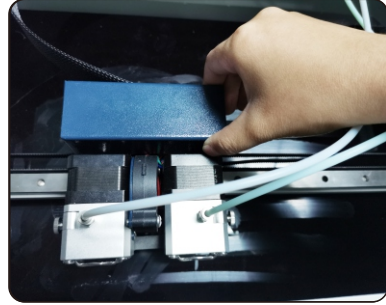
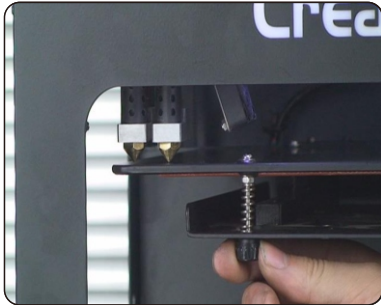

I Leveling platform manually

1. Turn on the printer.
2. On touch screen, press "Move axis" -> "All home"
3. Then "-Z" -> 100mm.
4. Move the extruder by hand to 4 corners of bed. Tighten or loosen 4 black nuts below the bed to make sure the distance between nozzle and bed is 0.2mm around. (Approximately the thickness of one piece of name card)
5. All home secondly.
6. "-Z"-->100mm secondly. Focus on the distance between the nozzle and bed. It needs to be 0.1mm around. If the distance too far, increase Servo Z offset value (+0.1mm each time). If too close or touch the bed, decrease Servo Z offset value. (-0.1mm each time).

II Auto leveling

1: Enter "Setting"->"Auto leveling" ->"Probe". Machine will start to detect 25 points.

Note: Servo Z offset means vertical height between nozzle and detector when probe needle outstretch. It is a fixed value if you don't change hotend or detector.

Contact us for videos. Or Youtube enter keywords **CreatBot F430 leveling bed**

Printer Operation

Load Filament

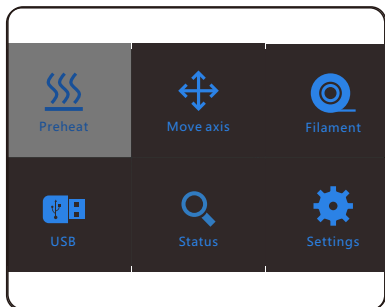

Preheat head



Load filament

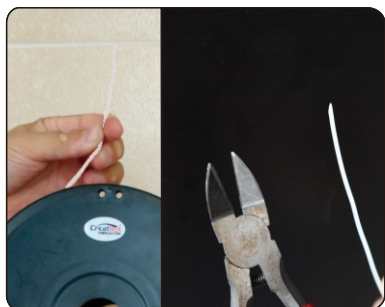

Sharpen and straighten filament head

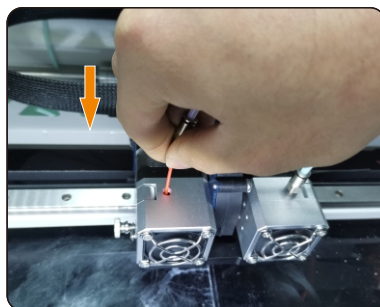

Get filament through

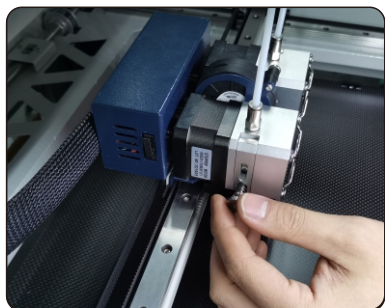

Tighten pressure nut

- 1.Preheat nozzle first.
- 2.Twist the printed parts,and load filament roll. Get filament through guide tube until extruder. Sharpen and straighten filament head,and check filament if they wind themself.
3. Loosen pressure nut (no need to remove),put filament into extruder hold and press filament to nozzle,until filament are extruded well. (Using skills see page 34)
- 4.Tighten pressure nut. (twist pressure nut 8~12 times after nut touch spring. Neither too loose,nor too tight)



Notice: Pressed filament too tight or too loose will affect normal wire feeding.

Printer Operation

Unload Filament

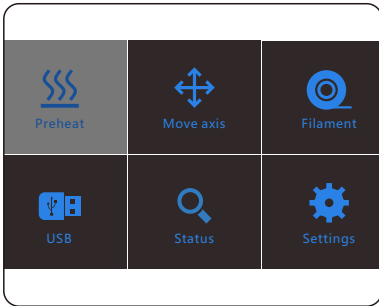

Unload filament menu

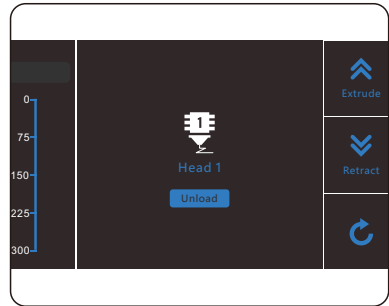

Preheat head

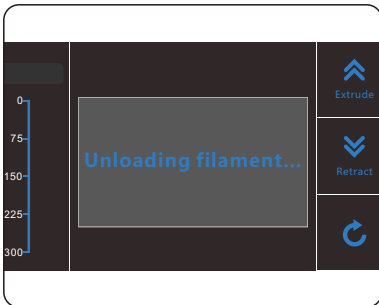

Unloading filament



Pull out filament

1. Enter "Filament" menu -> "Unload filament", and select the head you want unload.
2. Wait for the nozzle heated to a suitable temperature.
3. After reaching temperature, feeder will send a certain number of filament, and then automatically withdraw filament.
4. To manually unload filament, same as above mentioned.



Warning: It is strictly prohibited without heating nozzle.



Tip: If filament stuck in the guide tube, continue printing several lengths and retry.

Printer Operation

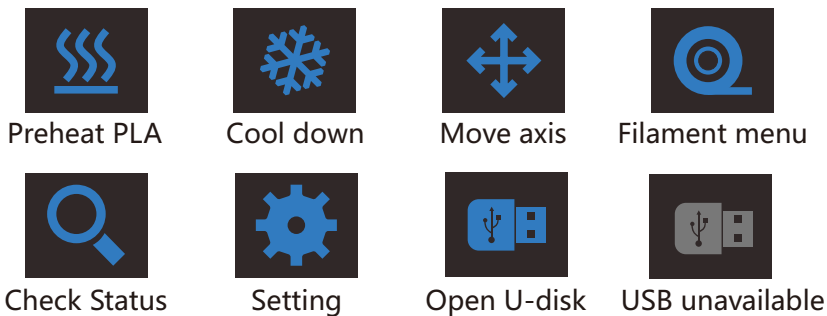
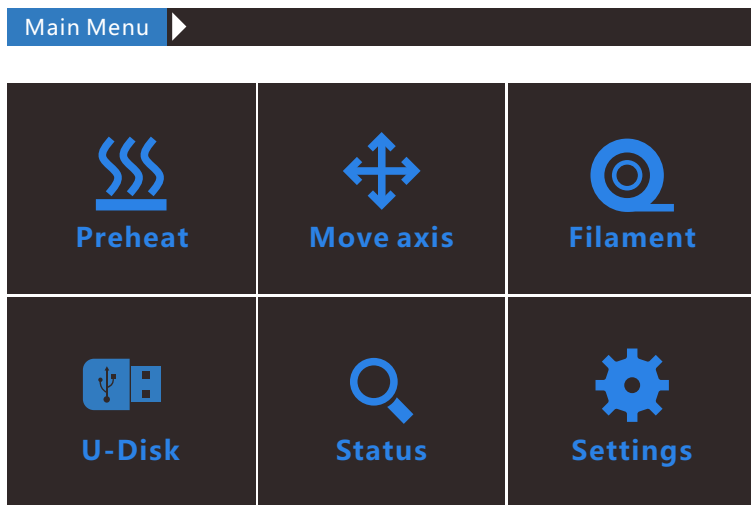

Printer Operation

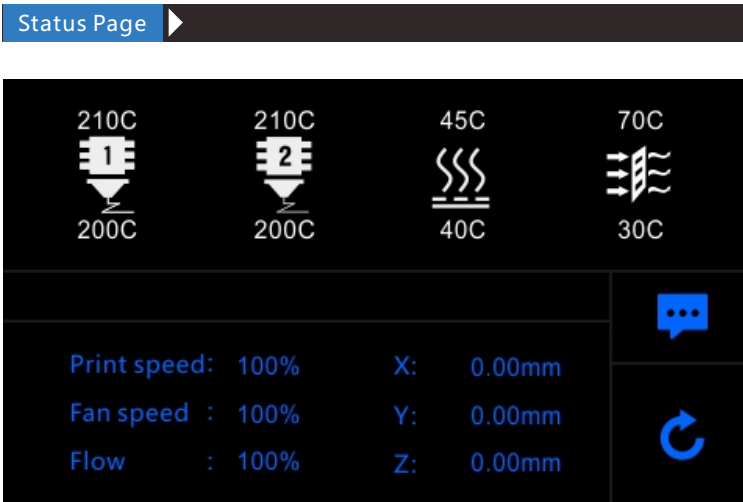

 **210°C** Touch and set up the temp of the nozzle.
210°C Target temp.1
200°C Current Temp.1

 **45°C** Touch and set up the temp of the hotbed
45°C Tar.hotbed.temp
40°C Cur.hotbed.temp







Print speed: 100% Printing speed **X:00.00** X,Y,Z current
Fan speed : 100% Fan speed **Y:00.00** position of
Flow : 100% Flow **Z:00.00** hotend.

 Use information

 Back

Printer Operation

Detail page ▶

 210C 200C	 210C 200C	 45C 40C	 70C 30C
Print speed: 100%			
Fan speed : 100%			
Flow : 100%			
X: 0.00mm	Y: 0.00mm	Z: 0.00mm	

 **210°C** Touch and set up the temp of the nozzle.
210°C Target temp.1
200°C Current Temp.1

 **45°C** Touch and set up the temp of the hotbed.
45°C Tar.hotbed.temp
40°C Cur.hotbed.temp

50.00% Current printing progress

Print speed:100% Printing speed
Fan speed:100% Fan speed

Flow:100% Flow
Z: 0.00mm Current Z position

 Use information  Setting  Back

Printer Operation

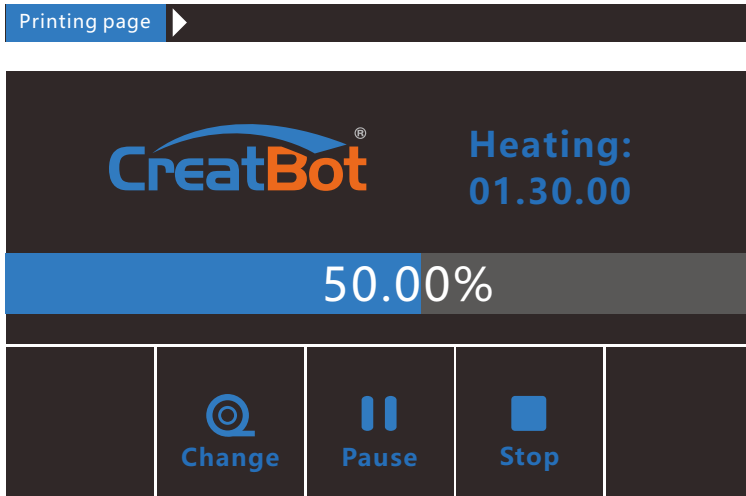

 50.00% Current printing progress

 Heating: 01.30.00 Time printed



Pause and Change filament.



Continue printing



Pause print



Cancel print



Z up



Z down



*The display will get darken when no operation in ten seconds and can be waken by clicking anywhere on the screen.
When the display shows the default print page, click anywhere except the buttons to turn back to the print details page.*



Printer Operation

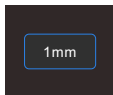
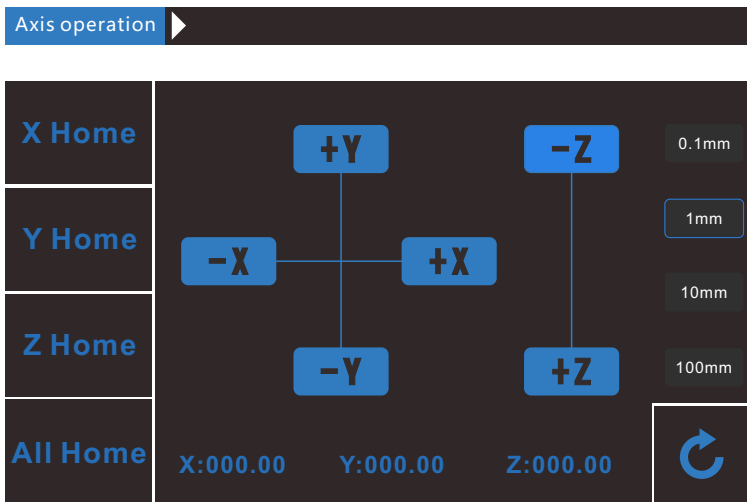

Minimum units



Move X to home



Move X/Y axis



Move Y to home



Z up

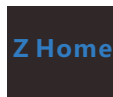

Move Z to home



Z down

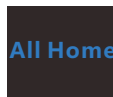

All axis to home

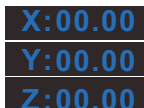

X,Y,Z current position of hotend.



Back

Printer Operation

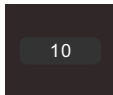
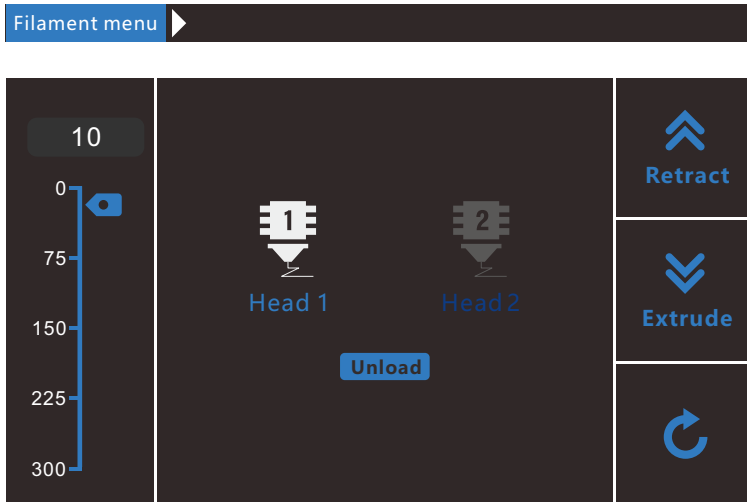

Click and enter a value

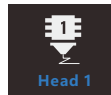

#1 extruder

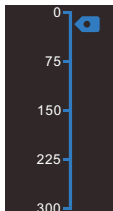

Adjust value when extrude/retract filament



#2 extruder (unavailable)

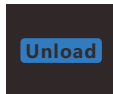

Retract filament



Retract filament



Extrude filament



Back



When you want to remove the filament, you need first to heat the extruder.

Printer Operation



file1.gcode
file2.gcode

Click and choose a file to print



Last page



Next page



Superior menu



Back

Printer Operation

Setting menu ▶

Motor		Reset	
X step:	106.6666		Z step:
Y step:	106.6666	E step:	130.0000
Preheat		Save	
Extruder temp.:	210°C		Fan speed :
Bed temp.:	45°C	More▼	

Fan speed

Sink fan speed :

Filter fan speed :

X step: 106.6666 Z step: 640.0000 X/Y/Z and extruder motor setting (range:5-9999)
 Y step: 106.6666 E step: 130.0000

Extruder temp. 210°C Fan speed : 0 % Preheat setting.
 Bed temp. 45°C Hotend (range 0~400)
 Fan speed (range 0-100)
 Bed temp.(range 0-120).

Sink fan speed : 100 % Sink fan speed (range 0-100)
 Filter fan speed : 100 % Filter fan speed (range 0-100)

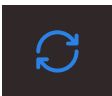

Reset



Save



Back

Printer Operation

Info. page ▶

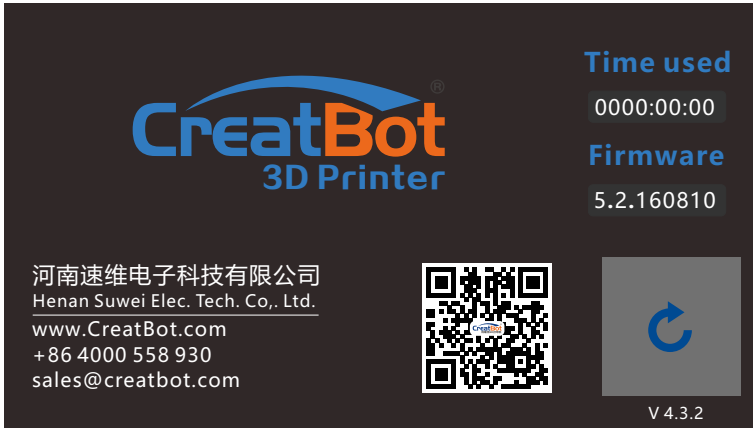

CreatBot®
3D Printer

河南速维电子科技有限公司
Henan Suwei Elec. Tech. Co., Ltd.
www.CreatBot.com
+86 4000 558 930
sales@creatbot.com

Time used
0000:00:00

Firmware
5.2.160810

V 4.3.2

Time used 0000:00:00	Print time used	V4.3.2	Screen version
Firmware 5.3	Firmware version		Back

Software Operation

CreatWare Setup

Download CreatWare installation package from the CD-ROM or www.CreatBot.com, follow the prompts to install the software, try using the default installation path as well.

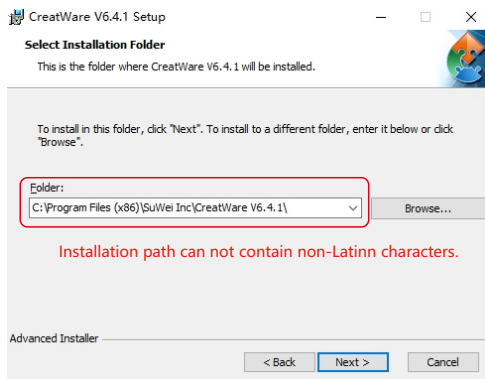
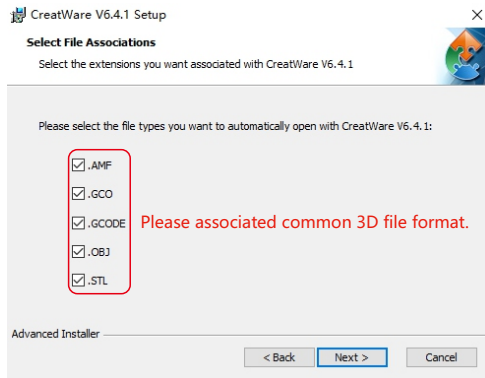

Please associated common 3D file format.

When there is a driver digital signature, please choose to agree. When finished the driver folder will locate at installation directory.

The software will select the correct language according to your OS, please select the right machine type and number of nozzles and ignore the other option and guide.

Software Operation

Quick Print UI



When insert SD card, the toolpath will saved to the SD card.

The file name can not contain non-Latinn characters.

Print Your First Model

Insert U-Disk to the card reader, open the CreatWare, load 3D model file[1], choose correct filament and option [2], finally click save button[3], you can now finish slice model.

Insert U-Disk to the printer, browse and select the Gcode file you just saved, the printer will automatically start to heating, when the temperature reaches, the printing will start.

Software Operation

Full Setting UI

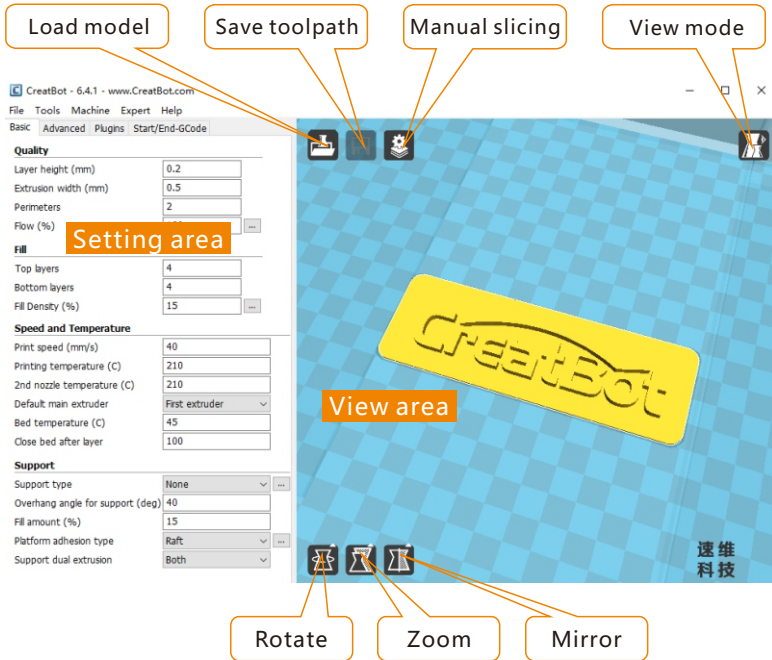

As you can see from the complete UI, the left side of the software is setting area, the right side is view area. The setting area contain "Basic", "Advanced", "Plugins", "Start/End GCode" four tabs. The Basic tab is the most common settings, usually the most frequently used parameters are here. Each parameter has a mouse-over tips, you can set parameters according to the prompt. If you want to restore the default settings, please click on the menu "Tools" -> "Restore Default".



Tip: Double-click view area can quickly load 3D model file.

The view mode and edit icon will appear when you select the 3D mode.

Software Operation

Mouse Operation

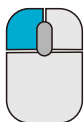

Left click

Select model, hold and move to change position, double-click to load 3D models.



Right click

Hold and move to rotate the viewpoint around the 3D model.

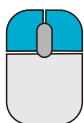

Left + Right

Hold and move the mouse to zoom.

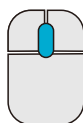

Scrollwheel

Use the scroll wheel to zoom in or out.

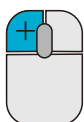

Left + Shift

Click and drag in rotary model can according to each 1 degree angle.

Shift

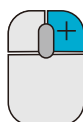

Right + Shift

Hold and move the mouse to pan the 3D view.

Shift

Keyboard Shortcut

Ctrl+L Load model/Picture

Ctrl+S Save model as

Delete Remove model

F5 Refresh view area

Ctrl+E Export setting

Ctrl+, Preferences

Software Operation

Model Rotate

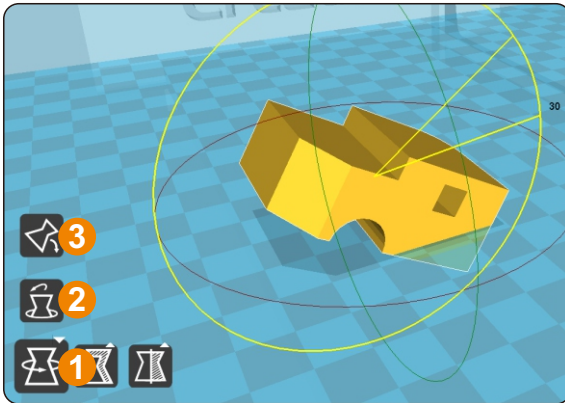

Click on the left corner of the rotate button [1], you can see three ring line around the model, respectively along the X, Y, Z direction. The default rotation angle is 5 degrees, press the Shift key can restrict the rotation angle to 1 degree.

Button [2] is the reset button, can restore rotate status to the default state.

Button [3] is lay flat button, can lay the model flat on the platform automatically.

Model Scale

Click the left corner of the zoom button [1], you can see a contour line around the model, and shows the current size of the model. You can input the value of the zoom ratio in Scale X / Y / Z , may also directly enter the size you need. Button [4] indicates locking scaling.

Button [2] is zoom reset button, you can restored the model to the default size.

Button [3] for the zoom model size to the maximum print size.

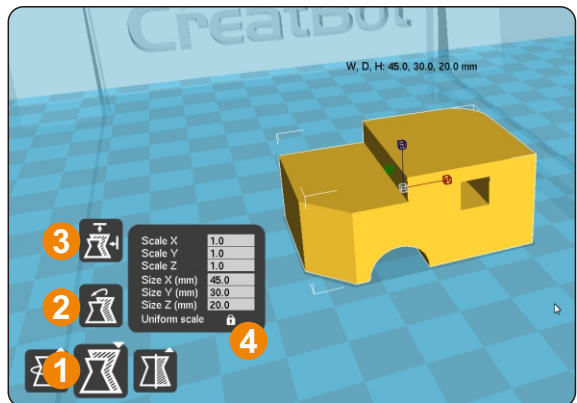

Software Operation

Model Mirror

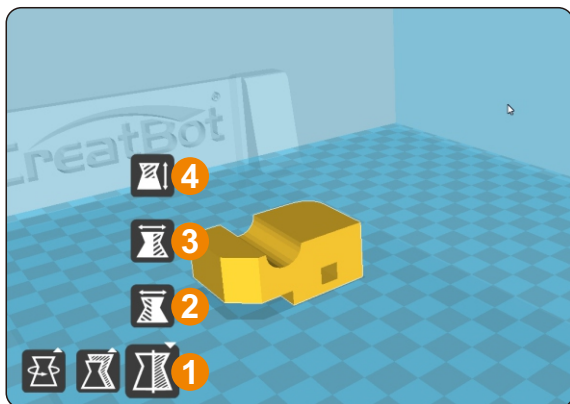

Click the mirror button [1], you can pop up the mirror menu.

Button [2] is a mirror along the X axis.

Button [3] is a mirror along the Y axis.

Button [4] is a mirror along the Z axis.

Note that the mirror transformation is different from the rotation, such as the mirror transformation will lead to a change in the direction of rotation, and the rotation will not change the model.

View Mode

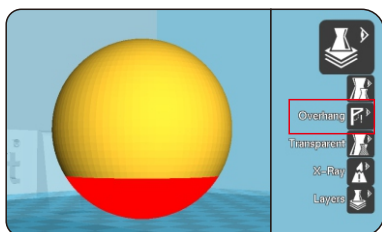

From the overhang view, you can see the suspended part of the model which is shown in red color. By changing the supporting angle can be seen suspended parts size is dynamically changing.

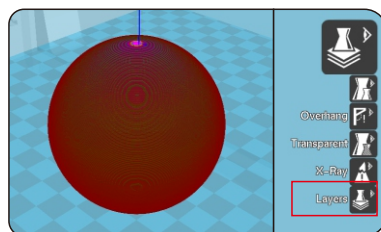

By slice view can easily observe the generated path, you can easily observe the different layers of sliced by slicing altitude indicator, use Ctrl + arrow keys can also be observed layer-by-layer.

Software Operation

Right Click on Model

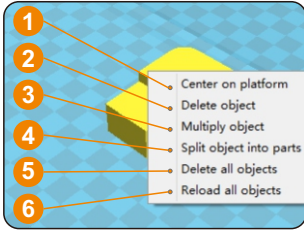

Right-click on the model pop-up shortcut menu, here are more features:

[1] "Centered" make the model back to the center position of the platform. [2] "Delete" to remove the currently selected model. [3] "Multiply" to copy the currently selected model and automatically position, which is useful for printing more than one model at a time. [4] "Split" multi-

component model can be split into its separate components, this process more time-consuming, try to split the model in the modeling software, models splited can be printed individually and then assembled together. [5] "Delete All" to delete all the models loaded. [6] "Reload all" Reload all models, same as F5.

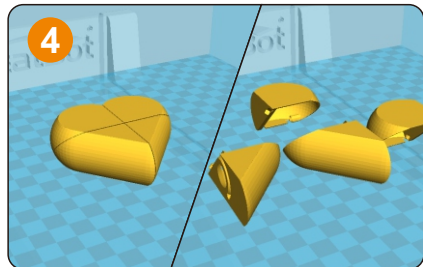
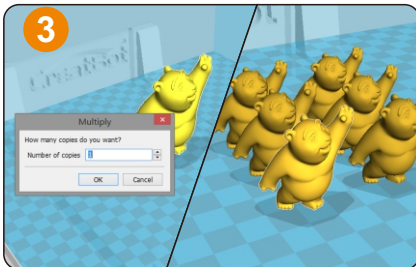

Toolpath Structure

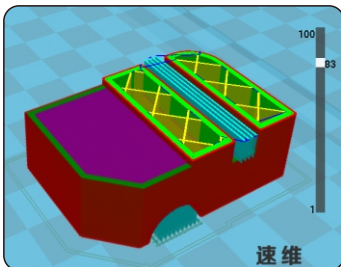

- Red represents "outer shell"
- Yellow represents "infill"
- Green represents "inner shell"
- Blue represents "support"
- Purple represents "bottom and top shell"

Drag layer indicator can browse different level paths, Ctrl + arrow keys to browse layer by layer. 3D printing is the superposition of these different layers and built layer by layer.

Software Operation

Basic Setting

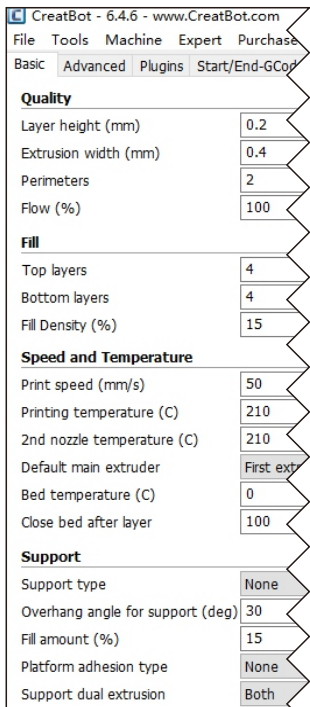

Layer height: This is the most important setting to determine the quality of your print, maximum value not exceed 80% of the nozzle diameter.

Shell thickness: Refers to the total thickness of the inner and outer walls, the outer wall is only one, the inner wall can be more, set this value to an integer multiple of the diameter of the nozzle.

Flow: Refer to the amount of printing material, 100% standard dosage, the more material the model prints more plump.

top/bottom thickness: Is the thickness of the upper and lower models, usually a multiple of layer height.

Fill density: Control how density filled the insides of your print will be, a value around 20% is usually enough, 0% for hollow.

Print speed: Speed at which printing happens. Print speed is affected by many factors, it is recommended to use low speed for complex model, high speed will cause the feed shortage, need improve nozzle temperature to compensate.

Nozzle temperature: Is the melting temperature of filament, general use 200 °C for PLA and 240 °C for ABS.

Bed Temperature: General use 45 °C for PLA and 70 °C for ABS.

Default main head: The default is the first nozzle, can also be set to other nozzles, this can reduce the times of changing filament.

Support type: The touching build plate support type is shown in figure [A], everywhere support is shown in figure [B].

Support angle: The larger the angle, the more support generate.

Fill amount: The larger the fill, the more support generate.

Platform adhesion type: The model which is not easy adhesion

on the platform please use Brim, which easy to warped or ABS filament please use Raft.

Support Type

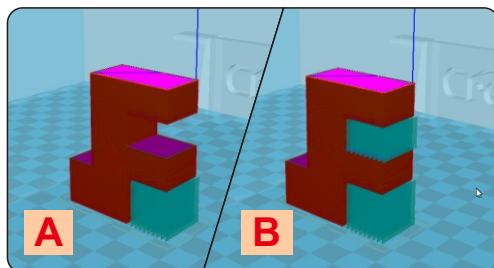

Software Operation

Advanced Setting

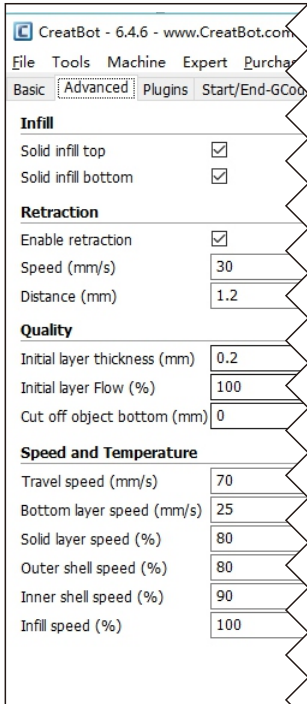

Solid fill top: Refers to whether to print the top surface of the model, uncheck will print it with infill method.

Solid fill bottom: Same as above, and so on.

Spiralis print: Refers to the method of spiral printing the outer wall of the model (single layer), and this feature is very suitable for print glass vase model.

Enable retraction: When the nozzle is moving over a non-printed area, withdraw a certain length length filament to prevent overflow.

Retract speed: The speed of retraction, too fast can lead motor out of step, too slow increase printing time.

Retract distance: The length of the filament when enable retraction.

First layer thickness: Height of the first layer of printing, generally greater than 0.15mm.

First layer flow: When the set of the first layer is too high, it can be appropriate to increase the extrusion.

Cut off object bottom: This can be used for objects that do not have a flat bottom.

Continue print: Being "power outages continued" be substituted.

Travel speed: The speed when moving over a non-printed area.

First layer speed: Slightly slow speed can enhance adhesion

model on the platform.

Solid layer speed: The speed is a percentage here, which reference to the global print speed, a combination of different speeds, you can both get a good print quality and a faster print time.

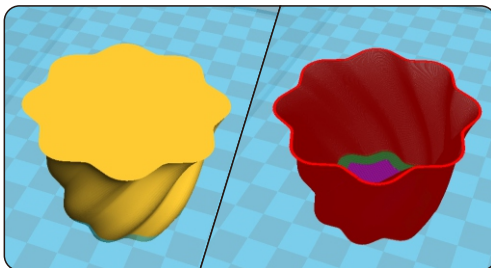

Spiralise Printing

Software Operation

Export Setting

Nozzle size: Set the nozzle size.

Diameter: Accurate measurement of your filament gives better quality prints.

Minimum travel: The minimum distance which can trigger filament retract.

Minimum extrusion: The minimal amount of extrusion that needs to be done before retracting.

Enable combing: Combing is the act of avoiding holes in the print for the head to travel over.

Wipe tower: Is a small tower next to your print where the nozzle wipes itself clean when switching nozzles.

Dual extrusion switch amount: Amount of retraction when switching nozzle with dual-extrusion, a value of 15mm seems to generate good results.

Cooling fan: The extra cooling fan is essential while printing small model, but when print ABS material, the max fan speed should not more than 50%.

Skirt: The skirt is a line drawn around the model at the first layer. This helps to prime your extruder, and to see if the model fits on your platform.

Brim: The amount of lines used for a brim, more lines means a larger brim which sticks better.



Notice: Most of the setting have been optimized, If you want restore default configuration, use the menu "Tools" -> "Reset profile to default".

Software Operation

Skirt · Brim · Raft

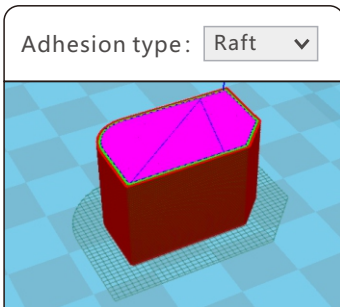
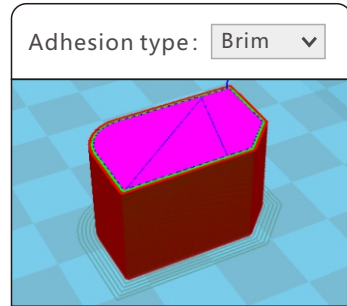
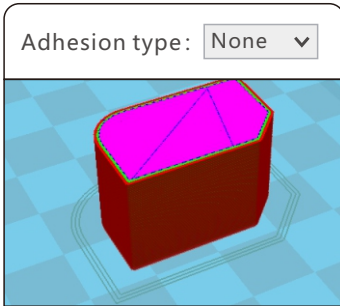

Plugin enable you to easily include your own features, without having to modify the source code or Gcode. In the screen shot above, these can be enabled by clicking on the arrow down button, then you can configure the plugin.



Notice: Please remove the plugin before you close the software.

Plugins

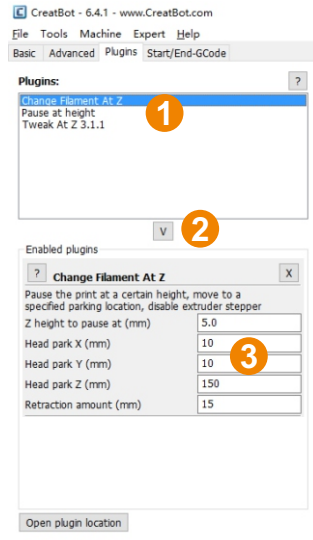

Software Operation

Start / End GCode

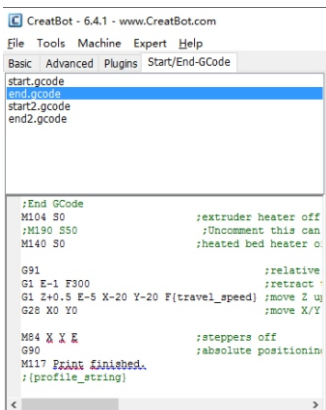

The start and end gcode are the startup and end procedure of the print, editing this requires knowledge of GCode.

If you want to set the automatic heating station after printing, you can remove the ";" in the code ";M190 S50".

start.gcode is the start code of single extruder, start2.gcode is the start code of double extruder, and so on.

Dual Head Printing

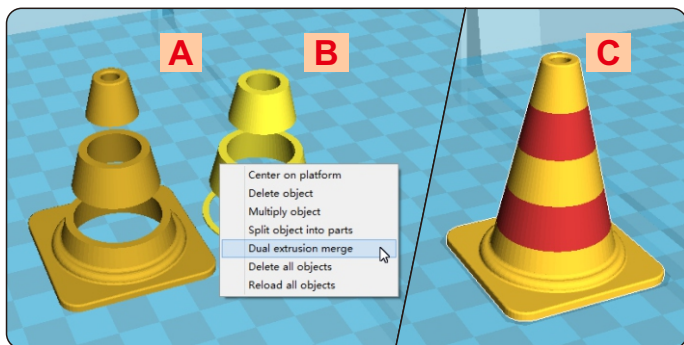

Step 1: Load 2 models you want as shown in figure [A] and [B].

Step 2: First click [A], then right click on [B], you will get the option: dual extrusion merge, this will merge both models into

one model [C].

Step 3: Set parameters like ordinary single color model and save the GCode.



Tip: The model select first will print by main extruder, the right clicked one by second extruder.

Software Operation

Align Dual Head Horizontal

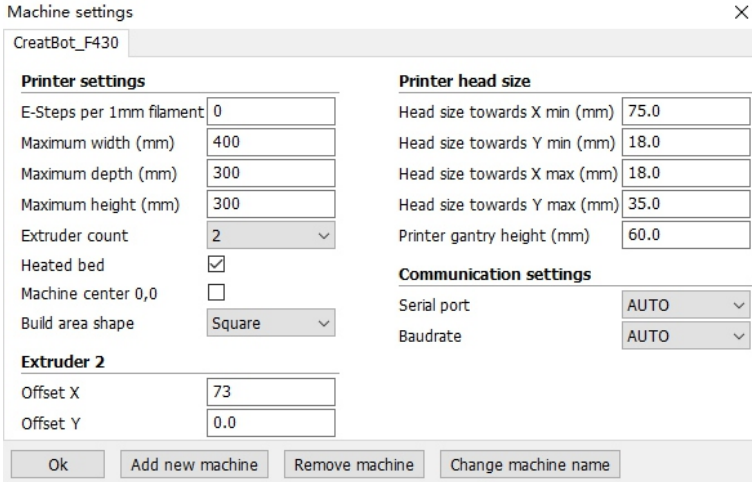

There are alignment problem while printing dual color model, this is because the small difference in multi-nozzle assembly, CreatWare built fine-tuning features.

Click menu "Machine">"Machine settings", default X offset is: 20.0, default Y offset is: 0.0, adjustment method as shown below:

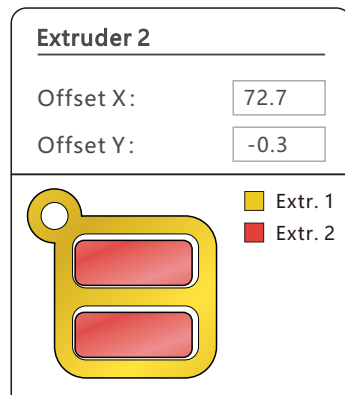
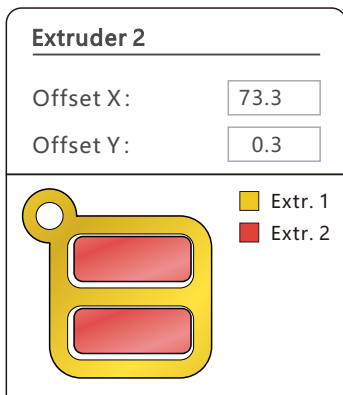

Software Operation

Add Multi Type Printer

You can add more than one type of CreafBot to the software, and easily switch between them without re-config all the different machine settings.

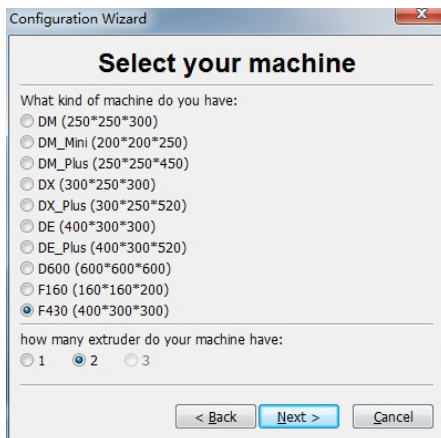
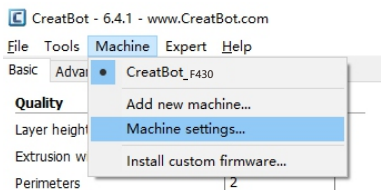

Print Setting Of Different Filament

	Nozzle temperature	Hot bed	Plantform adhesion type	Fully enclose or not
PLA	190~210°C	None/45°C	None/Raft	Can open
ABS	240~250°C	90°C	Brim/Raft	Enclosed
Nylon	240~270°C	100°C	Brim/Raft	Enclosed
HIPS	230~260°C	100°C	None/Brim	Enclosed
PETG	230~260°C	100°C	None/Brim	Enclosed
Flexible	210~230°C	None/45°C	None	Can open
Wood	190~220°C	None/45°C	None	Can open
PC	230~260°C	100°C	Brim	Enclosed
PEEK	380~430°C	Bed 120°C/Air 70°C	Raft	Enclosed

* The data is only for reference, different environmental data will be different. F160 and F430 can print PEEK.

Using skills

Change Fuse



Open fuse tray



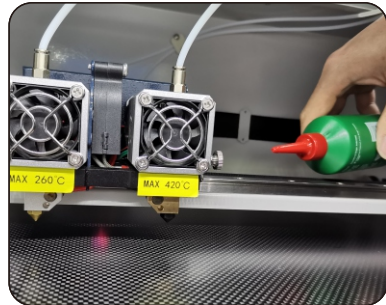

Change new fuse

Routine Maintenance

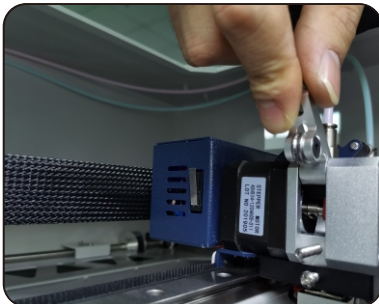

1. Frequent cleaning stains on the rail.
2. Lubricate the four guide rail.
3. Frequent cleaning feeder gear.



 *Notice: Don't add too much lubricating oil.*

Using skills

Installation section

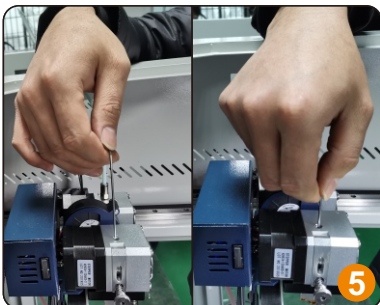
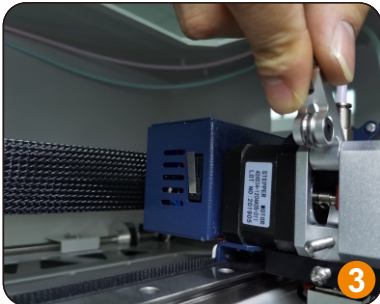
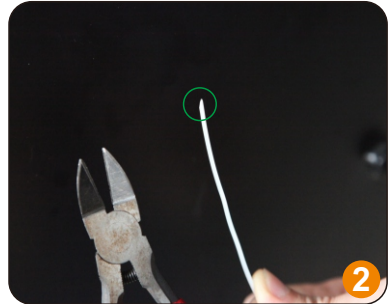

Using skills

1. Better to use printed spool holders. According to curl direction of filament, Get filament through guide tube can prevent winding filament.
2. After preheating nozzle, Sharpen and straighten filament head is necessary. This will get filament through extruder easily.
3. If you can't send filament through nozzle well, remove pressure nut and pressure spring first. Then open pressure arm and clear filament scrap. Sight guide hole and send filament well.
4. Tighten pressure nut. (twist pressure nut 8~12 times after nut touch spring. Neither too loose, nor too tight)
5. Extrude filament for a while and pull out quickly when you change filament. Otherwise, filament may block inside heatbreak. Or choose "Change Filament" on touch screen.
Use the small stick to poke filament out if there are filament scrap block inside heatbreak or nozzle.

Software

1. If your machines are equipped with different diameter nozzle (default 0.4mm). You have to setting:
 - Expert-open expert setting... Nozzle size (same to yours)
 - Basic-Quality-Extrusion width (same to yours)
2. Small objects need lower hotend temperature around 190~200°C.
Large objects better to use Support-Raft. Easy to stick when start printing. Easy to remove when finish printing.

Frequently Asked Questions

Hardware Troubleshoot

1. Display "MINTEMP" ?

The environment is too low, or temperature sensor is damaged, please keep the room temperature above 0°C.

2. Display "MAXTEMP" ?

Temperature of nozzle or bed too high, or temperature sensor is damaged, please keep their temperature in a suitable range.

3. USB connection problems ?

Please specify the correct port and baud rate (250000), or change a shorter USB cable.

4. Nozzle heats up too slowly ?

Temperature in door is too low, or use a fan duct, or turn up output voltage (24.5v).

5. Print head stuck ?

Clean the guide rail and add lubricating oil.

6. Print head can not move ?

Stepper motor chipset burned, or belt damaged, or belt wheel screw loose.

7. Print head hit the framework ?

Corresponding axis stop limit or circuit fault.

8. Unable to power on ?

Power switch is damaged or fuse is burned, and please check whether the power adapter is working properly or power check board is damaged.

Printing Troubleshoot

1. How to set the temperature of the nozzle ?

Different filament temperature is different, general as follows:

PLA temperature 190°C ~210°C, bed 45-60°C

ABS temperature 230°C ~250°C, bed 80-100°C

You must leave enough time for filament heating, so the faster printing speed need the higher temperature, 60mm/s temperature need raise about 10°C. In the same way, larger thickness need higher temperature.

2. How to set the temperature of the hot bed ?

The main purpose of the hot bed is to prevent model wrapped, PLA need about 45°C and 70°C for ABS is enough, but due to the environment and filament, we often need to increase the temperature, the highest temperature

Frequently Asked Questions

Printing Troubleshoot

not over 120°C, and you can close the bed above 100mm except printing ABS or other high-temperature required filaments.

3. The model not stick on the platform ?

Please paste masking paper or Kapton tape on the platform, or the nozzle is too far away from the platform, or the bottom of the model is not leveled.

4. No or less silk coming on the first layer ?

The distance between nozzle and platform is too small, or the filament has not been sent to the nozzle.

5. Why nozzle is not spit silk ?

The filament is not pressed or too tight, or print temperature is too low, or the filament feeder not working.

6. How to prevent model become warped ?

Increase hot bed temperature or use Kapton, or change platform adhesion type to Raft, or cover the baffle, or reduce indoor ventilation.

7. How far from nozzle to platform appropriate ?

Distance should be 0 in theory, but there is no absolutely flat platform, so the distance should ± 0.1 mm. Finally, with the actual printing effect as the standard, too close will lead to a silk blocked, too far will cause the model not stick on the platform.

8. How to determine whether the temperature is too high ?

PLA temperature is too high will appear liquefaction, ABS will be the carbide, that will block the nozzle.

9. What reasons will causing nozzle blocked ?

Filament are impurities or print environment dust too much, bad of thermal conductivity between the nozzle and the heating block.

10. Model surface is loose with crack ?

The layer is too high or the printing speed too fast, nozzle temperature too low or filament press nut too loose, or filament is blocked.

11. How to print a small model ?

Multiple the model, and print them at a time.

12. Dual color model not aligned ?

Adjust offset of second nozzle in machine settings.





13. Dual color model color interference ?

Align two nozzle in vertical direction



14. There is too much silk drag on the model ?

Please enable filament retraction, and specified proper retract speed, and distance, the retract distance should not less than 2mm, and the speed not less than 30mm/s.

Specifications

				
Model	DX	DX Plus	DE	DE Plus
Build volume	300*250*300	300*250*520	400*300*300	400*300*520
Nozzles	Dual/Tris			
Diameter	0.4mm(0.3/0.6/0.8/1.0mm can be customized)			
Temperature	350℃			
Nozzles Type	print head/new print head			
Hot bed	100℃ (can be closed after certain layers)			
Min. Layer	0.04mm			
Accuracy	X、Y、Z axis 0.01mm			
Print Speed	120mm/s (inner/outer, top/bottom, fill, first layer speed can be set separately)			
Travel Speed	200mm/s			
Materials	ABS,PLA,TPU,PETG,HIPS,PVA, PA,PC,Carbon Fibre,etc			
Fila. Diameter	3.0mm (1.75mm optional)			
Keypad	Yes (nine key)			
Auto Turnoff	Yes (pwr manager + relay)			
Continue Play	Yes (Power outage, lower plate and save data)			
Fila. Check	Yes (pause printing when filament finish, and lower platform)			
Adju. Head	Yes (height-adjustable-nozzles)			
OS	Windows, Linux, Mac OS, OSX			
Languages	Chinese, English multi-language			
Software	CreatWare Multi-language , Simplify3d			
File Format	STL, OBJ, GCode, Amf			
Chipset	Atmega 2560-16AU (AVR 8 Bit 16MHz, 256KB Flash)			
Display	128*64 monochrome multi-language (support color TFT)			
Pwr Supply	110/220V 360W		110/220V 700W	
Dimension	420*380*570	420*380*790	590*430*570	590*430*790
Weight	35 Kg	40Kg	45Kg	55Kg

Specifications

			
Model	F160	F430	D600
Build volume	160*160*200	400*300*300	600*600*600
Nozzles	Single	Single/Dual	
Diameter	0.4mm(0.3/0.6/0.8/1.0mm can be customized)		
Temperature	400 °C		350 °C
Nozzles Type	Direct drive		
Hot bed	140 °C	Bed 120 °C / Air 70 °C	100 °C
Min. Layer	0.04mm		
Accuracy	X、Y、Z axis 0.01mm		
Print Speed	120mm/s (inner/outer, top/bottom, fill, first layer speed can be set separately)		
Travel Speed	200mm/s		
Materials	ABS,PLA,TPU,PETG,HIPS,PVA, PA,PC,Carbon Fibre,PEEK,etc		
Fila. Diameter	1.75mm		3.0mm
Motion Structures	Optic axis		Rectilinear orbit
Auto Turnoff	Yes (pwr manager + relay)		
Continue Play	Yes (Power outage, lower plate and save data)		
Fila. Check	Yes (pause printing when filament finish, and lower platform)		
Adju. Head	Yes (height-adjustable-nozzles)		
OS	Windows, Linux, Mac OS, OSX		
Languages	Chinese, English multi-language		
Software	CreatWare Muti-language		
File Format	STL, OBJ, GCode, Amf		
Printing Field	Full closed covering		
Display	4.3 inches color touch screen		
Pwr Supply	110/220V 180W	110/220V 1300W	110/220V 1000W
Dimension	280*280*470mm	660*470*560mm	910*840*1100mm
Weight	22Kg	60Kg	170Kg

